

Thank you for choosing Wolverine

Having difficulty using this product?

Please try the following options:

- Call us at 949-458-9888 M-F 9:00-5:00 Pacific Time
- E-mail our technical support staff at support@wolverinedata.com

Technical Support

For technical support, warranty service, or repair service, please contact Wolverine Data at Support@wolverinedata.com or call 949-458-9888 M-F 9:00 - 5:00 at Pacific Time



MovieMaker Pro
8 mm/Super 8 Film to Digital

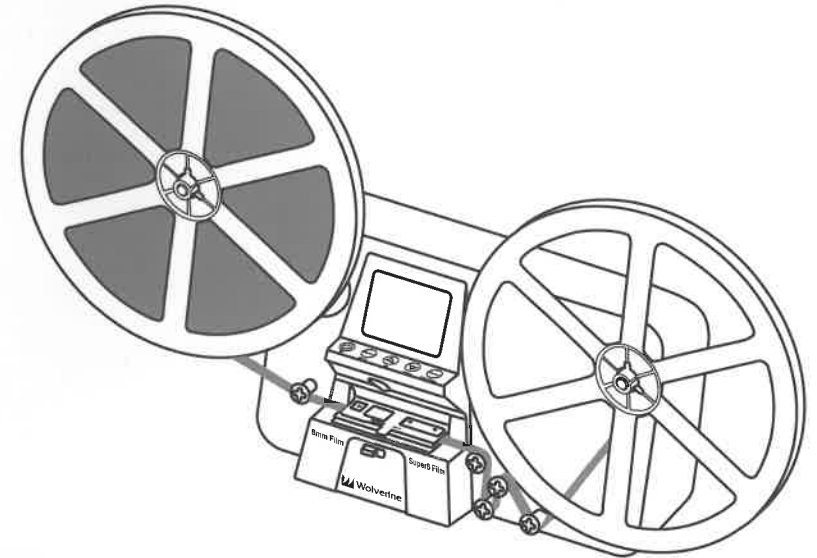

User Manual

Version 3.2

Table of Contents

Introduction ...1
Features ...1
Before Using MovieMaker Pro ...1
Having Difficulty Using This Product? ...3
Package Contents ...3
Film Type ...3
Function of Buttons ...3
Getting Started ...4
Preparing the Film ...4
Swinging up/down the Arm ...4
1. Attach Power Cord ...4
2. Insert SD/SDHC Memory Card (32 GB Maximum) ...4
3. Turn on/off MovieMaker Pro ...5
4. Clean the Light Table ...5
5. Mount the Reels and Film ...5
6. Menu Selections ...6
Record ...7
Frequent Asked Questions: Q&A ...7
Playback ...8
Rewind ...9
Exposure ...9
Sharpness ...9
USB ...9
Frame ADJ (Adjustment) ...10
Language, Format, Default Setting, Film Type ...10
Preview ...10
Connect to a TV Set ...10
Specifications ...10
Limited Warranty (United States Only) ...11
Warranty Exclusions ...12
Other Limitations ...13

Introduction

Your old 8mm and Super 8 films are degrading. Worse, the memories are fading and the film is becoming more brittle just sitting in the box. Convert your film into digital now before the memories are lost forever!

Introducing the Wolverine MovieMaker Pro. A simple to use device that will convert your movie reels into digital movies (no sound) with few strokes. Works like a typical projector where you mount the 3 inch or up to 9 inch reel, insert a memory card, press few buttons and the Wolverine MovieMaker Pro will scan frame-by-frame to create a digital MP4 movie file that you can play on any computer. You can also edit, upload movie files to internet or burn them to DVD's.

The Wolverine MovieMaker Pro pays for itself taking into consideration that photo labs are charging more than a dollar to digitize a single foot of film!

Features

- A fully automated apparatus to digitize 8 mm and Super 8 movies up to 9" reels into digital videos
- Frame-by-frame digitizing for high-quality digital output
- Stand-alone machine, no computer, no software, no drivers are required
- Scans and saves digital movies to maximum 32 GB SD/SDHC cards (not included). 64 GB or above memory card will NOT work with the device
- Converts 8 and Super 8 movies into MPEG-4 (MP4) digital movie files at 1080P/20 fps
- Compatible with all Windows, Mac and Linux Operating Systems
- Playback the digital movies to TV using the included TV Cable

Before Using the MovieMaker Pro

This section provides important safety information that you should read before operating the device.

- Do not drop or handle too aggressively as it may cause damage to the device.
- 8 mm or Super 8 media **MUST** be mounted in/with proper reel (up to 9" in diameter) and adapter, before recording/rewinding.

- Do not record/rewind the films if they are broken, ruptured, gapped sprocket holes, or misaligned, overlapped, bent. Improper operations can damage the device. Wolverine Data is not responsible for consequential damages and warranty will be void.
- Do not allow the device to come into contact with water or other liquids. In the event that water or other liquids enters the interior, immediately turn off the device. Continue using the device may result in fire or electrical shock.
- We strongly suggest using a non-alcohol lint-free clean-dry cloth to clean the light table panel and your film, to produce high quality videos. Improper cleaning may damage components. Wolverine Data is not responsible for consequential damages and warranty will be void.
- Do not handle the device with wet hands. Doing so may cause electrical shock and damages to the unit.
- Do not expose the device to extreme temperatures, humidity, vibrations or drop, which may cause damage to the device.
- Do not disassemble the housing or lubricate parts. This unit does not require or contain batteries. Under no circumstances should users try to repair the device. Doing so may cause electrical shock and WILL VOID the warranty. If the device is mishandled, Wolverine Data is not responsible for consequential damages, including loss of data.
- Wolverine Data has no obligation to repair, replace or issue refunds without a Return Merchandise Authorization (RMA) number and the original purchase receipt of the defective product.
- Repairs or replacement service will not be offered to products that were misused, repaired without authorization, or other reasons beyond the range of intended use.
- Replacement products may be either new or refurbished, provided that it has functionality at least equal to that of the product being replaced.
- Wolverine Data is not responsible for any data stored on the returned product, please backup any data prior to shipping the unit.
- All out of warranty repairs may be subject to repair fee. Please contact your dealer or Wolverine Data for current charges.

Having Difficulty Using This Product?

Please try the following options:

- Call our technical support or sales at 949-458-9888
M-F 9:00-5:00 Pacific Time
- Visit www.wolverinedata.com/support to watch the video manual or find the latest Q&A, documentation and other help tips
- E-mail or write to our technical support staffs at **support@wolverinedata.com** or **9939 Muirlands Blvd. Irvine, CA 92618**

Package Contents

1. MovieMaker Pro x 1
2. Power Adapter (12V, 1.5A) x 1
3. USB Cable x 1
4. TV-OUT Cable x 1
5. 5" Reel (8 mm diameter center hole) x 1
6. Reel Adapter (Red x1, Gray x1)
7. Brush x 1
8. User Manual x 1

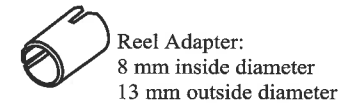

Film Type

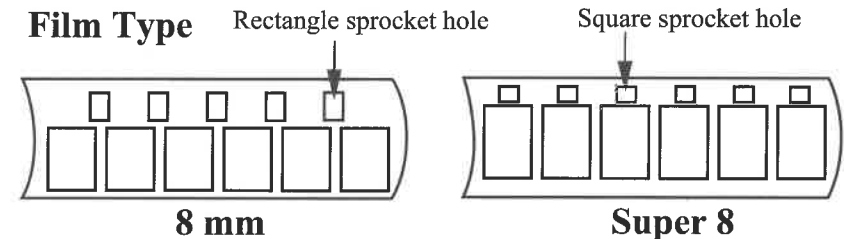

Function of Buttons

1. Power button: To turn power on or off.
2. Up or Down arrow buttons: To highlight Menu item on LCD viewer.
3. Enter/Start/Stop button: To Start/Stop highlighted item.
4. Menu button: To go back to Menu selection; Press twice to go Menu mode or record mode.

Getting Started

Preparing the Film

If your film is not in good condition such as dusty, broken, ruptured sprocket holes, misaligned, taped overlap, bent, spliced, gluey, or thick, please check and fix the film problems first. Otherwise it may be stuck on film track, or damage/jam/stop MovieMaker Pro, or produce poor quality or jittery videos.

Also if some older films have been wound too tight, you might use MovieMaker Pro to rewind it back and forth to regain proper winding tightness before convert them. Tight-wound film may cause jittery in the recorded videos.

We strongly recommend before you record your films, use lint-free cloth and/or anti-static film cleaner to remove and clean dirt particles, chemical residues, or any scattered mildew on the film in order to avoid poor quality videos, or stoppages during the recording process.

Swinging Up/Down the Arm

Swing up the arm to mount reel; push down the arm for storage purpose.

1. Attach Power Cord

Plug in the included DC 12V power adapter.

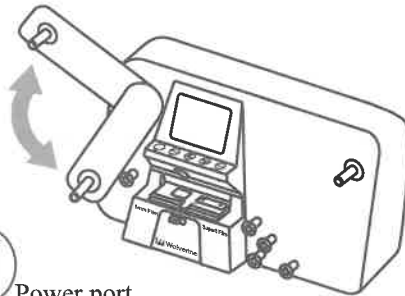
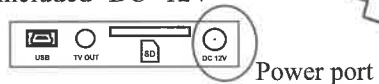

2. Insert SD/SDHC Memory Card (32 GB Maximum)

Insert SD/SDHC memory card before power on the MovieMaker Pro device.

- Using a Micro SD card with adapter, or SDXC card, or memory card that is 64 GB or above capacity, which is not compatible with MovieMaker Pro will lead to a "**Card error**" message to appear on the screen. The MovieMaker Pro can only take a SD/SDHC memory card up to **32 GB** maximum.

4

- Make sure the SD/SDHC card is unlocked (white tab in forward position).
- Insert and push the SD/SDHC card inward until it clicks. Improper insertion may damage the card reader or the SD/SDHC Card, which neither is covered under warranty.
- To dismount/eject the SD/SDHC card, first push the card in then release, instead of pulling it out directly. MovieMaker Pro will power off automatically if the SD/SDHC card is being mounded/dismounted.

3. Turn on/off MovieMaker Pro

Press power button to turn MovieMaker Pro on/off.

4. Clean the Light Table

Push the film door tab left to flip open the door. Use included brush to clean the light table very gently.

5. Mount the Reels and Film

If your film reel has 8 mm mounting hole, mount the reel directly to the left shaft, otherwise use the provided red color reel adapter. If adapters are needed, always place Red color adapter on the LEFT side; GRAY color adapter on the RIGHT side.

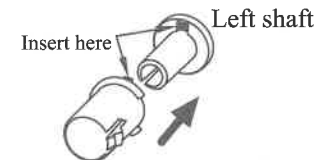

Left Reel Adapter (Red/No-Fin)

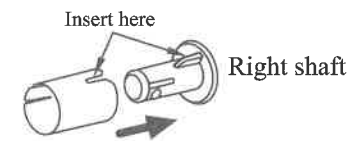

Right Reel Adapter (Gray/Finned)

- Mount empty reel on to the right shaft.
- Follow the Film Routing Diagram printed on the face of MovieMaker Pro to route the film. We strongly recommend users to follow the winding scheme to generate better quality videos.

5

- Slide open the flap door, position film sprocket holes at the top. Place film underneath the 3 white tabs. Otherwise, the recorded videos will be jittery.

Steps to place film on table:

1. Place and hold film underneath Tab #1
2. Twist film slightly and clip film underneath Tab #2
3. Twist film slightly and clip film underneath Tab #3

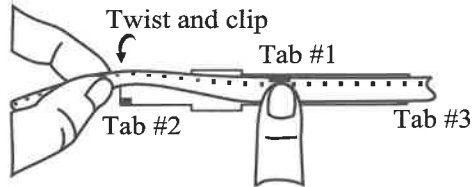

- Make sure the film is properly placed underneath all 3 white tabs, then close the flap door.

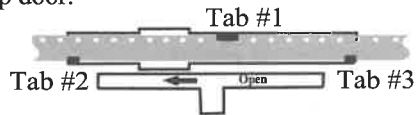

6. Menu Selections

Press the Menu button. Use Up or Down arrow button to highlight the Menu selection and then press Enter.

Record	Exposure	Frame ADJ	Default Setting	Preview
Playback	Sharpness	Language	Film Type	
Rewind (More ▾)	USB (More ▾)	Format (More ▾)	Version (More ▾)	
1st page	2nd page	3rd page	4th page	5th page

Note:

If non-default settings are needed, any adjustments or value changes need to be done before commencing record/convert.

Record

1. Slide the Film Selection Lever left (8 mm) or right (Super 8) to select proper film type. Then press Enter button.

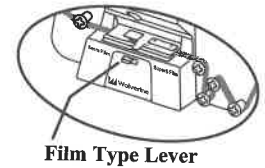
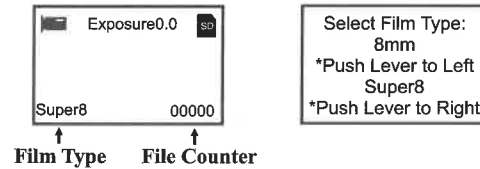

2. Press Enter/Start/Stop button to **start** recording. While recording is in process, a red dot at upper left corner blinks.
3. Press Enter/Start/Stop button to **stop** recording.
4. The film reel counter at lower right corner will increase by one after each recording stops.

Frequent Asked Questions:

Q: My film has imperfect splices, bent, and broken sprocket holes; it is stuck and won't advance through the machine.

A: Do not stop recording. Open the flap door while film stuck. Manually pull/push the problematic section to the right side, away from pin movement. Then close the flap door and continue recording.

Q: Some segments of recorded video showed jittery and some are not

A: Your film might have been played on projector too many times, which damaged the sprocket holes (see picture below), which lead to jittery video. Use the side of good sprocket holes by first rewinding the film then record it backward. Then, play the backward video file on computer, and use editing functions on software such as "Windows Live Movie Maker" or "iMovie" to reverse them.

If jittery happened on all recorded files, run a Full Format on memory card, to wipe out bad sectors of the memory card, then redo the recording.

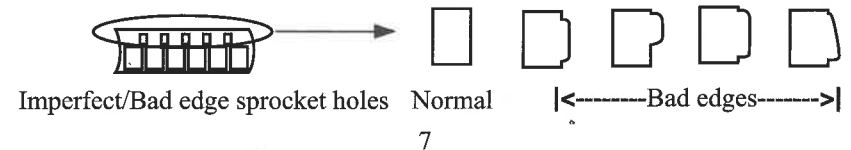

Q: My film won't go through the MovieMaker?

A: Some old film came a little wider than 8mm at some sections due to loose manufacturing tolerance of film, and caused the Wolverine having hard time pulling the film through the track table. A trick to keep the flap door from closing all the way may help overcoming the problem of slightly wider film to go through the track table. Please visit our web site and click on the SUPPORT tab to find help in the file "Wider_Film_solution.pdf"

Q: The speed of the video is too fast/slow. Can I change it?

A: Users who wish to modify playback speed of the video from the default 20 fps to other desirable speed, could use "iMovie", or free software "Windows movie maker" from Microsoft, or "VLC" from videoland.org, to edit and save the desirable playback speed. The above mentioned software are not affiliated or supported by Wolverine Data.

Please visit our web site www.wolverinedata.com and click the SUPPORT tab to find other Q and A and help videos.

Playback

1. Press Menu button, highlight the Playback selection, then press Enter.
2. Press Up/Down arrow button to select the film file to be Playback, then press Enter/Start.
3. Press Enter/Stop to pause the playback.
4. Press Menu button one time to enter Edit mode. Highlight Return (go back to Playback) or Delete (delete the current file).
5. Press Menu button twice to go back to the Record mode or Main/Home menu.

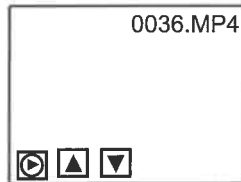

Note for Mac users:

Mac computer will create and add hidden files to SD/SDHC memory card each time when user playbacks the recorded MP4 movie files on Mac. With the hidden files or modified MP4 files stored on the SD/SDHC memory card, MovieMaker Pro can no longer "Playback" movies on the above SD card. A "No File" message will be displayed on the Viewer instead.

Rewind

1. Remove film from Light Table and swap reels. Place **empty take-up reel** on the **right** side shaft and place sprocket holes on the outside (as shown). If reel adapter is needed, always place gray adapter on the right side/take-up reel.
2. Follow the film rewind routing diagram (the dotted lines) printed on the MovieMaker Pro and follow the instructions on the screen.
3. Press Enter button to Start/Stop the rewinding process.

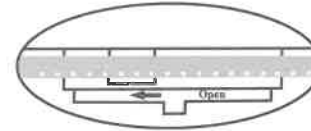

Exposure

Mount **Empty** reel on **Right** side when rewinding

Exposure Value/brightness needs to be adjusted before recording if default setting (0.0) is off.

1. Adjustable exposure range is from 2.0 to -2.0.
2. Press Up/Down key to change the value and press Enter to complete the change.
3. The default setting is 0.0. Negative value provides a darker effect and Exposure 2.0 shows the brightest result.



Sharpness

If sharpness adjustment is needed, make a change **before** recording.

1. Sharpness range is from Low to High. The default setting is Medium.
2. Press Up/Down to change the value and press Enter to complete the change.



USB

Plug in the included USB cable to upload recorded MP4 files. The SD/SDHC memory card is read as an External Drive, called NO_NAME drive (G:)*. The stored MP4 files are located under the directory of **FilmScanner/MOVIE**.

*Note: (G:) may vary from computer to computer.

Frame ADJ (Adjustment)

You can make movie frame adjustments on the screen. Press **Up/Down** button then **Enter** button to adjust. After completion, press **Menu** button to go back. Adjustments should be made **before** recording.

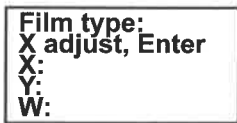

- ← 8MM or SP8
- ← Select X or Y or W by pressing Enter button
- X = shift frame center to left or right
- Y = shift frame center up or down
- W = zoom-in or zoom-out frames

Language

English and Japanese are available on the MovieMaker Pro.

Format

Highlight Yes or No to erase all files on the inserted SD/SDHC memory card.

Default Setting

Reset all values to manufacturing setting (0.0 or medium).

Film Type

Positive and Negative film are available on the MovieMaker Pro.

Preview

Preview film frame by frame without recording.

Connect to a TV set

You can use your TV screen as the default viewer.

1. Turn on MovieMaker Pro and TV.
2. Set TV input to A (or TV, TV) mode.
3. Connect MovieMaker Pro "TV OUT" port to TV's Video-In port (yellow) with the included TV-Out cable.
4. The viewer on MovieMaker Pro will turn dark and everything shows on your TV screen instead.

Specifications

Image sensor: 3.53 Mega pixels (2304H x 1536V) 1/3" CMOS sensor

Display: Color 2.4" TFT LCD

Exposure control: Auto/Manual (-2.0 to 2.0)

White balance: Auto

Resolution: 1080P

Playback frame rate: 20 frames per second

Scan method: Video

Film type: 8 mm and Super 8 roll film in 3" or up to 9" reel

Picture effects: Positive

File format: MP4

TV-OUT type: NTSC/PAL

Built-in memory: None

External memory: Accepts **SD/SDHC** card up to **maximum 32 GB** (card not included)

Power Supply: DC 12V

Interface: USB 2.0

Language: English and Japanese

Support system: Window XP/Vista/Windows 7,8,10/Mac 10.7.3

Dimension: 12 in x 6.5 in x 4.4 in (30.4 cm x 16.6 cm x 11.3 cm)

Weight: 3.6 lb (1.62 Kg)

Caution: This device complies with part 15 of the FCC Rules. Changes of modifications not expressly approved by Wolverine Data could void the user's authority to operate the equipment.

Limited Warranty (United States Only)

Wolverine Data warrants that the hardware products it manufactures will be free from defects in materials and workmanship. The limited warranty term is one year beginning on the date of invoice, or less than 200 reels converted (Counter#), whichever occurs first. Also this product is not intended for commercial use or rental. Should this unit be used at any time for commercial purposes or as a rental unit, the limited warranty period for parts and labor shall be 90 days from the date of original purchase at retail. The opinion of Wolverine Data with respect to this matter shall be final.

Damage due to shipping the product to you is covered under this limited warranty. Otherwise, this limited warranty does not cover damage due to external causes, including accident, abuse, misuse, problems with electrical power, servicing not authorized by Wolverine Data, usage not in accordance with product instructions, failure to perform required preventive maintenance, and problems caused by use of parts and components not supplied by Wolverine Data.

The warranty extends only to the first consumer purchaser, and is not transferable. This limited warranty does not cover any items that are in one or more of the following categories: software; external devices (except as specifically noted); accessories or parts added to a Wolverine Data system after the system is shipped from Wolverine Data or its resellers; accessories or parts that are not installed in the Wolverine Data factory.

During the warranty period, beginning on the invoice date, Wolverine Data will repair or replace products returned to Wolverine Data's facility.

This limited warranty is valid only in United States.

To request limited warranty service, you must contact Wolverine Data's Technical Support Services within the limited warranty period. Refer to the section titled TECHNICAL SUPPORT to find the appropriate telephone number for obtaining customer assistance. If limited warranty service is required, Wolverine Data will issue a RMA (Return Material Authorization) Number.

You must ship the products back to Wolverine Data in their original or equivalent packaging, prepay shipping charges, and insure the shipment or accept the risk of loss or damage during shipment. Wolverine Data will ship the repaired or replacement products to you freight prepaid if you use an address in the continental United States, where applicable. Shipments to other locations will be made freight collect.

To obtain service, you must include: (a) a copy of your receipt or other comparable proof of purchase; (b) a written description of the problem; (c) your address and telephone number and Email address; (d) Write the RMA number on the outside shipping packaging.

NOTE: Wolverine Data uses new and reconditioned parts made by various manufacturers in performing limited warranty repairs and building replacement products. If Wolverine Data repairs or replaces a product, its limited warranty term is not extended.

Warranty Exclusions:

Normal Wear and Tear: Periodic maintenance, repair and replacement of parts due to normal wear and tear are excluded from coverage.

Abuse and Misuse: Defects or damage that result from: (a) improper operation, storage, misuse or abuse, accident or neglect, such as physical damage (cracks, scratches, etc.) to the surface of the product resulting from misuse; (b) contact with grease, lubricant, liquid, water, rain, extreme humidity or heavy perspiration, sand, dirt or the like, extreme heat, or food; (c) use of the products or accessories for commercial purposes or subjecting the product or accessory to abnormal usage or conditions; or (d) other acts which are not the fault of Wolverine Data, are excluded from coverage.

Use of Non-MovieMaker Pro Converters accessories: Defects or damage that results from the use of Non-MovieMaker Pro's accessories or other peripheral equipment are excluded from coverage.

Unauthorized Service or Modification: Defects or damages resulting from service, testing, adjustment, instillation, maintenance, alteration, or modification in any way by someone other than Wolverine Data are excluded from coverage.

Altered Products: Product or accessories with (a) serial numbers or date tags that have been removed, altered or obliterated; (b) broken seals or that show evidence of tampering; (c) mismatched board serial numbers; or (d) nonconforming or non-Wolverine Data parts or accessories, are excluded from coverage.

Other Limitations

Any implied warranties, including without limitation the implied warranties of merchantability and fitness for a particular purpose, shall be limited to the duration of this limited warranty, otherwise the repair, replacement or refund as provided under this express limited warranty is the exclusive remedy of the consumer, and is provided in lieu of all other warranties, express or implied. In no event shall wolverine data be liable, whether in contract or tort (including negligence) for damages in excess of the purchase price of the product, accessory or software, or for any indirect, incidental, special or consequential damages of any kind, or loss of revenue or profits, loss of business, loss of information or data, software or application with the ability or inability to use the product, accessories or software to the full extent these damages may be disclaimed by law. Some states (or jurisdictions) do not allow the exclusion or limitation of incidental or consequential damages, so the above exclusion or limitation may not apply to you.